



FusionKraft™

Gynaecology
Instruments Catalogue

www.myraandcompany.in

Myra & Co.
launches

FusionKraft™

General Vascular

Ophthalmic

Neuro

Plastic

Micro

Cardiac

Thoracic

ENT Gynaecology

Orthopaedics

SCALPEL HANDLES



DRESSING FORCEPS

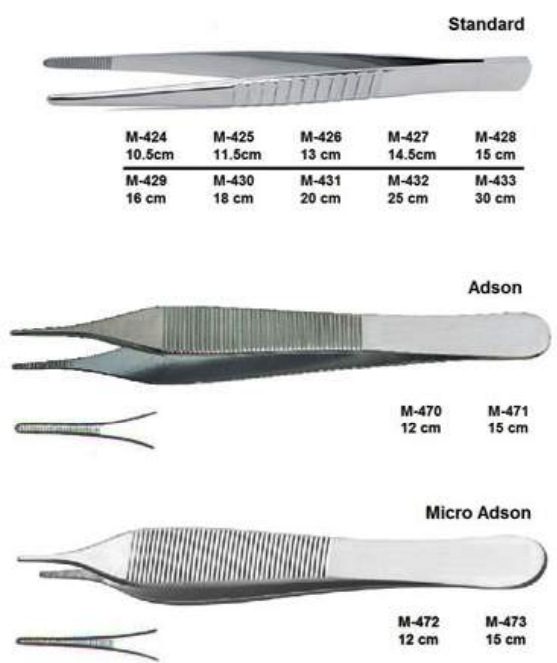



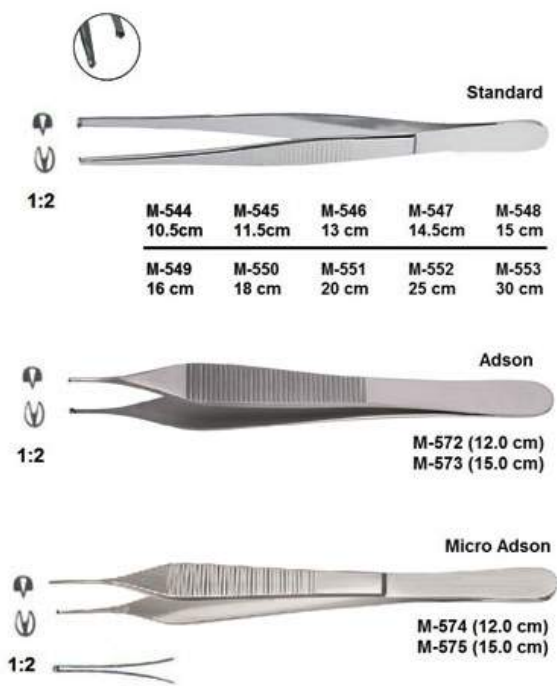



TISSUE FORCEPS









SUCTION TUBES



OPERATING SCISSORS

Straight	Straight	Straight	Curved	Curved	Curved
					
<p>STANDARD</p> <p>M-241 (10.5 cm) M-242 (11.5 cm) M-243 (13.0 cm) M-244 (14.5 cm) M-245 (15.5 cm) M-246 (16.5 cm) M-247 (17.5 cm) M-248 (18.5 cm) M-249 (20.0 cm)</p>	<p>STANDARD</p> <p>M-250 (10.5 cm) M-251 (11.5 cm) M-252 (13.0 cm) M-253 (14.5 cm) M-254 (15.5 cm) M-255 (16.5 cm) M-256 (17.5 cm) M-257 (18.5 cm) M-258 (20.0 cm)</p>	<p>STANDARD</p> <p>M-259 (10.5 cm) M-260 (11.5 cm) M-261 (13.0 cm) M-262 (14.5 cm) M-263 (15.5 cm) M-264 (16.5 cm) M-265 (17.5 cm) M-266 (18.5 cm) M-267 (20.0 cm)</p>	<p>STANDARD</p> <p>M-268 (10.5 cm) M-269 (11.5 cm) M-270 (13.0 cm) M-271 (14.5 cm) M-272 (15.5 cm) M-273 (16.5 cm) M-274 (17.5 cm) M-275 (18.5 cm) M-276 (20.0 cm)</p>	<p>STANDARD</p> <p>M-277 (10.5 cm) M-278 (11.5 cm) M-279 (13.0 cm) M-280 (14.5 cm) M-281 (15.5 cm) M-282 (16.5 cm) M-283 (17.5 cm) M-284 (18.5 cm) M-285 (20.0 cm)</p>	<p>STANDARD</p> <p>M-286 (10.5 cm) M-287 (11.5 cm) M-288 (13.0 cm) M-289 (14.5 cm) M-290 (15.5 cm) M-291 (16.5 cm) M-292 (17.5 cm) M-293 (18.5 cm) M-294 (20.0 cm)</p>

						
<p>Incision Scissor</p> <p>M-295 (13.0 cm) M-296 (14.5 cm)</p>	<p>Deaver Straight</p> <p>M-297 (14 cm)</p>	<p>Deaver Curved</p> <p>M-298 (14 cm)</p>	<p>Mayo - Still Straight</p> <p>M-299 (15 cm) M-300 (17 cm) M-301 (19 cm)</p>	<p>Mayo - Still Curved</p> <p>M-302 (15 cm) M-303 (17 cm) M-304 (19 cm)</p>	<p>Mayo Straight</p> <p>M-305 (14.5 cm) M-306 (15.0 cm) M-307 (17.0 cm) M-307-A (19.0 cm) M-308 (23.0 cm)</p>	<p>Mayo Curved</p> <p>M-309 (15.0 cm) M-310 (17.0 cm) M-311 (19.0 cm) M-312 (23.0 cm)</p>

OPERATING SCISSORS

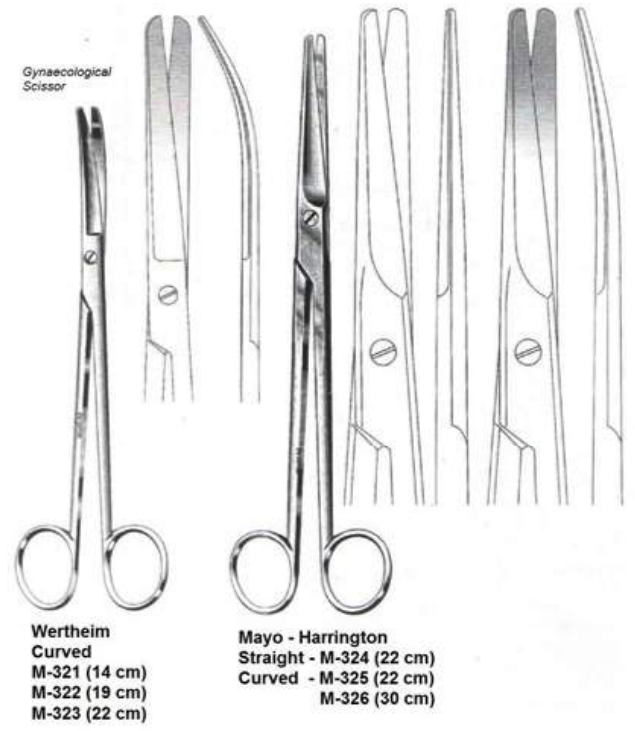
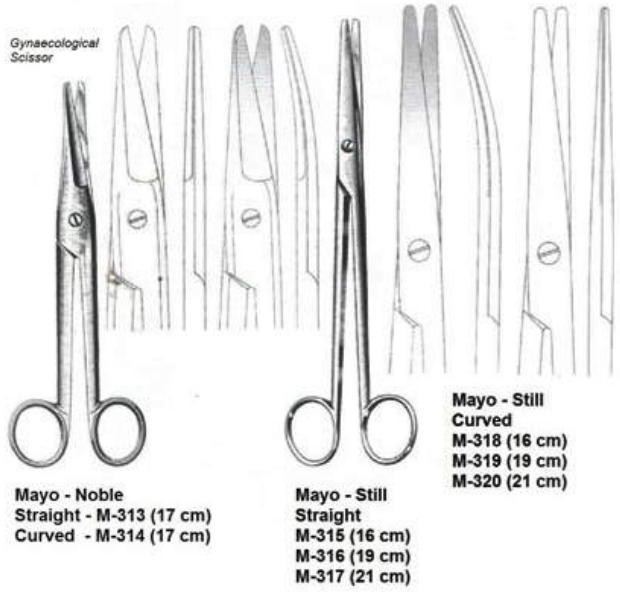

DISSECTING SCISSORS

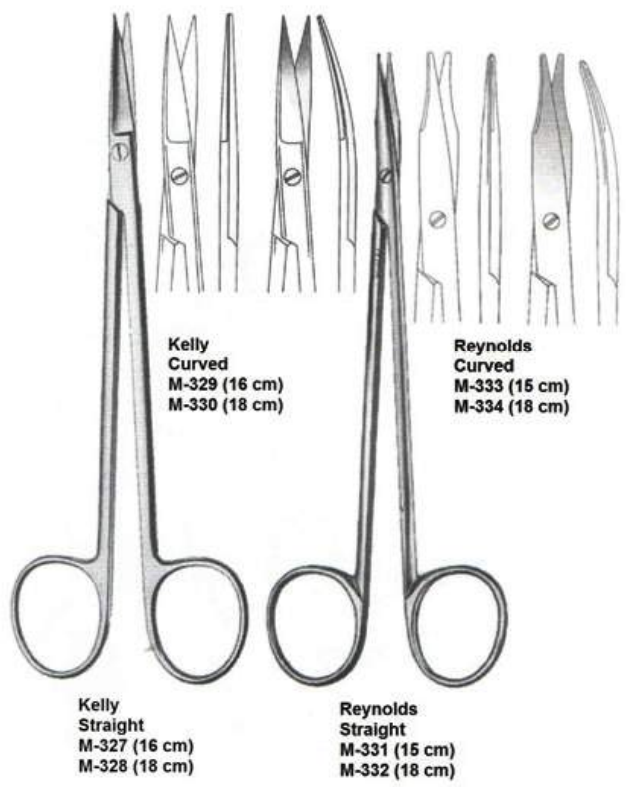

DISSECTING SCISSORS



DISSECTING SCISSORS

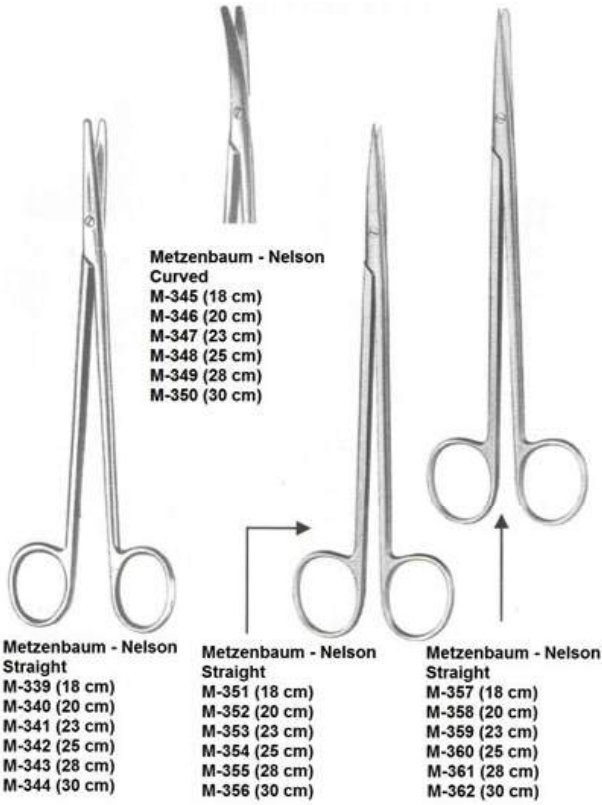

OPERATING SCISSORS

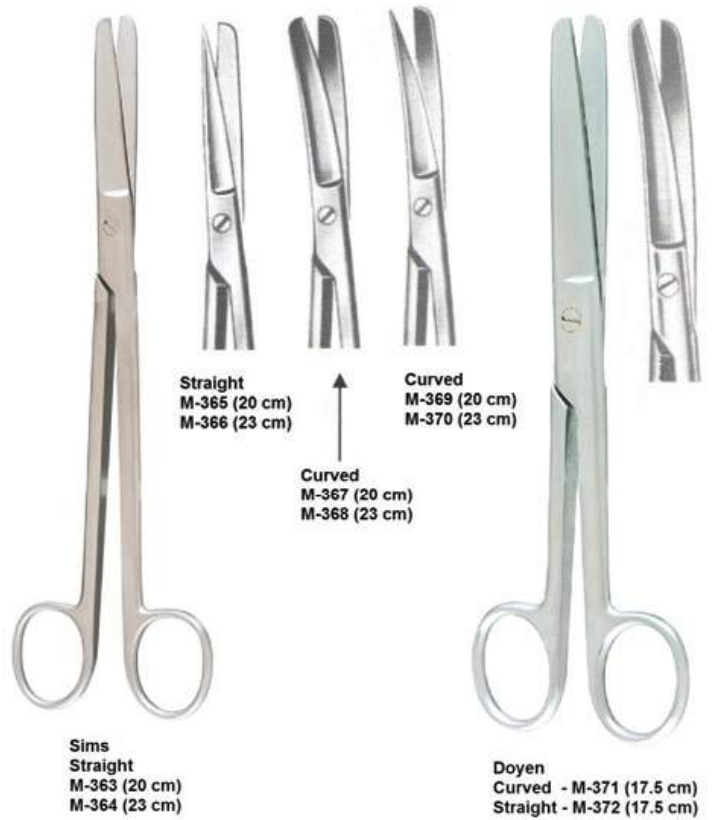

FINE IRIS SCISSORS



UMBILICAL SCISSORS



OPERATING SCISSORS

Gynaecological Scissors



Sims

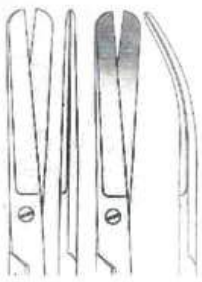

M-419 (20 cm)

M-420 (23 cm)



Locklin M-421 (16cm)

EPISIOTOMY SCISSORS



Braun Episiotomy Scissors
M-2027 (14cm)
M-2028 (21cm)

MICRO SCISSORS



M-720 (15.5 cm) M-720-C (15.5 cm)
M-720-A (18.5 cm) M-720-D (18.5 cm)
M-720-B (22.5 cm) M-720-E (22.5 cm)

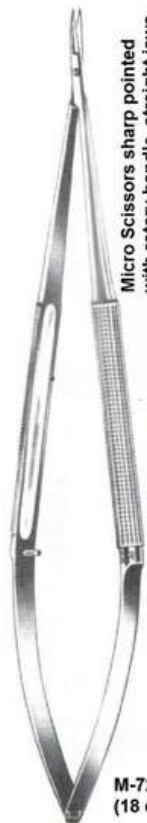

M-723-A (18 cm)

Micro Scissors sharp pointed with rotary handle, straight jaws, one blade with fine serrations.



M-723-B (18 cm) Straight

Micro Dissecting Scissors with rotary handle, tips and outside surfaces of blades rounded.



M-723-C (18 cm) Curved

SUTURE INSTRUMENTS



Richter-Heath M-723-R (14 cm)

ARTERY FORCEPS

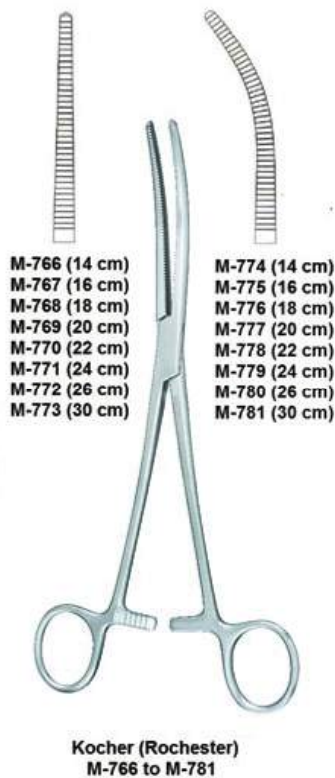
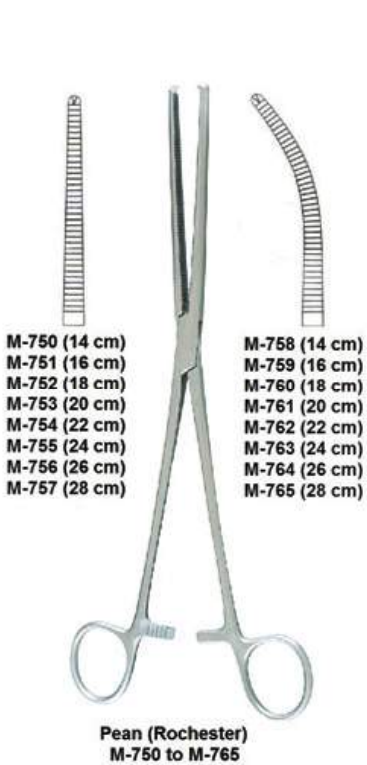
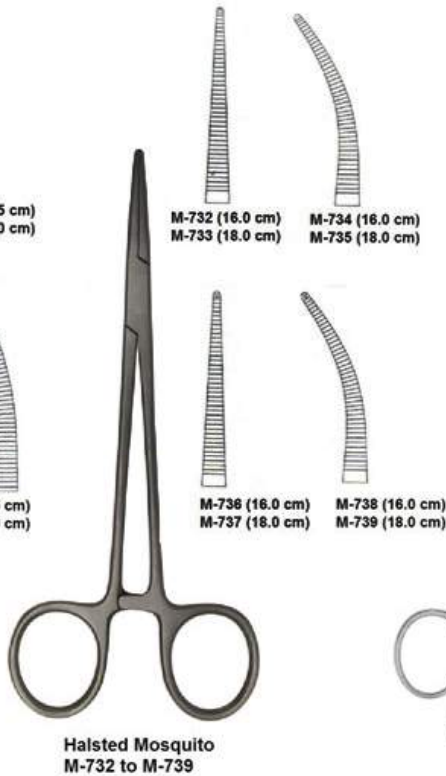
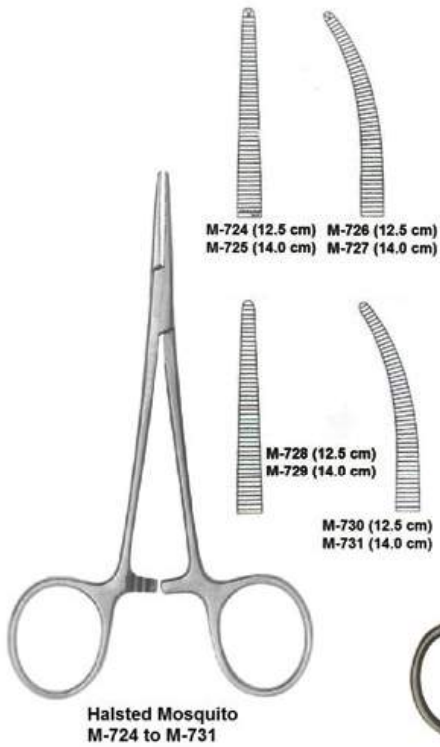

ARTERY FORCEPS

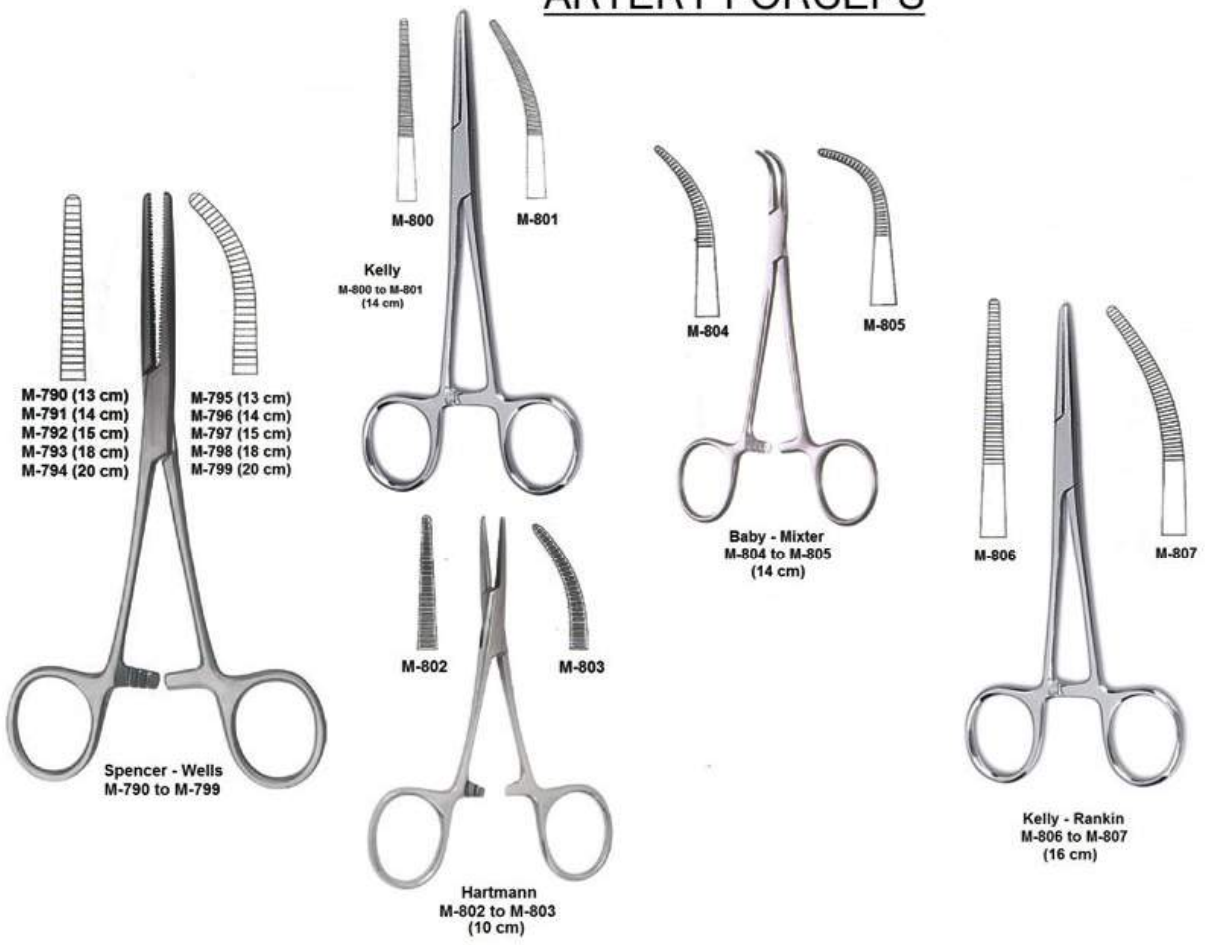

ARTERY & HYSTERECTOMY FORCEPS

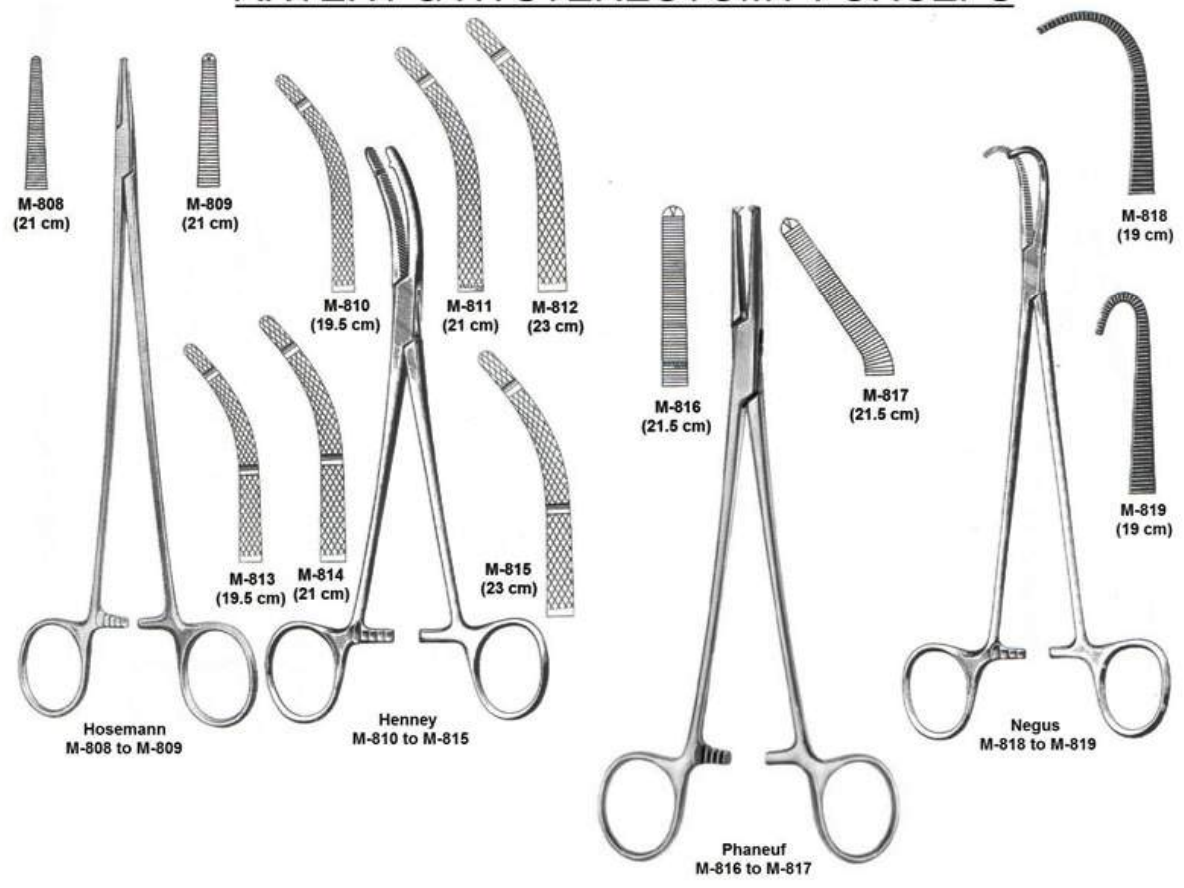

ARTERY FORCEPS



**De-Bakey Mixer Forceps
(Delicate, Rt. Angled)**

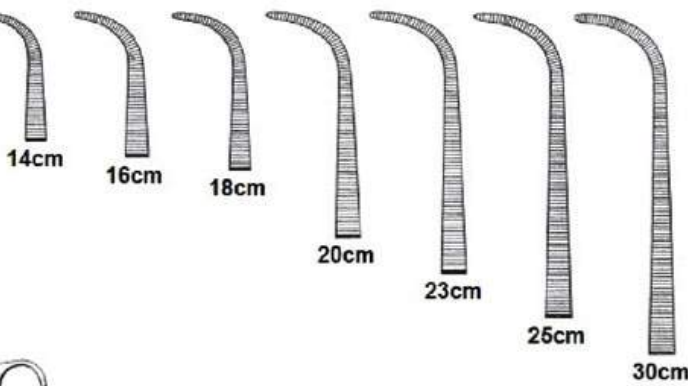

- | | |
|-----------------|-----------------|
| M-805.1 - 14cms | M-805.5 - 23cms |
| M-805.2 - 16cms | M-805.6 - 25cms |
| M-805.3 - 18cms | M-805.7 - 30cms |
| M-805.4 - 20cms | |

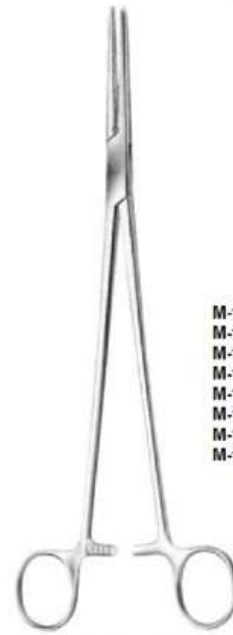

**Roberts Artery Forceps
(Serrated)**



- | | |
|---------------|---------------|
| M-1982 (13cm) | M-1990 (13cm) |
| M-1983 (16cm) | M-1991 (15cm) |
| M-1984 (18cm) | M-1992 (18cm) |
| M-1985 (20cm) | M-1993 (20cm) |
| M-1986 (23cm) | M-1994 (23cm) |
| M-1987 (25cm) | M-1995 (25cm) |
| M-1988 (28cm) | M-1996 (28cm) |
| M-1989 (30cm) | M-1997 (30cm) |

HYSTERECTOMY FORCEPS

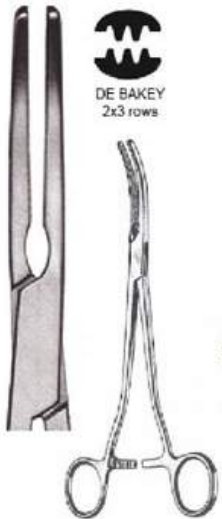

**Wertheim-De-Bakey
Hysterectomy Clamp Forceps
(With Atraumatic Serrations)**
 M-2085 - Straight, 25cm (Fig. 1)
 M-2086 - Slight Curve, 24.5cm (Fig. 2)
 M-2087 - Medium Curve, 24cm (Fig. 3)
 M-2088 - Strong Curve, 23.5cm (Fig. 4)
 M-2089 - Angled, 22.5cm (Fig. 5)



**Wertheim Atrauma
Vaginal Clamp
M-2040 (25cm)**



**Wertheim-Cullen
Pedicle Clamp
(Longitudinal Serrations)
M-2041 (21cm)**



M-1608 (Straight)



M-1608.1 (Angled Shaft)

**Green-Armytage
Haemostatic Forceps
(21cms)**



Maingot's Hysterectomy Forceps



- | | |
|-----------------|-----------------|
| M-2113 (20 cms) | M-2115 (20 cms) |
| M-2114 (24 cms) | M-2116 (24 cms) |

NEEDLE HOLDERS

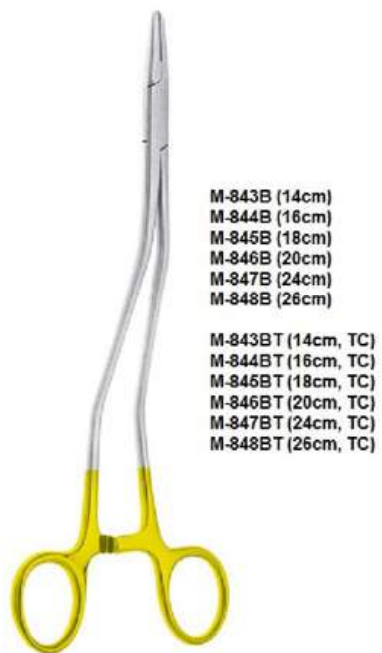
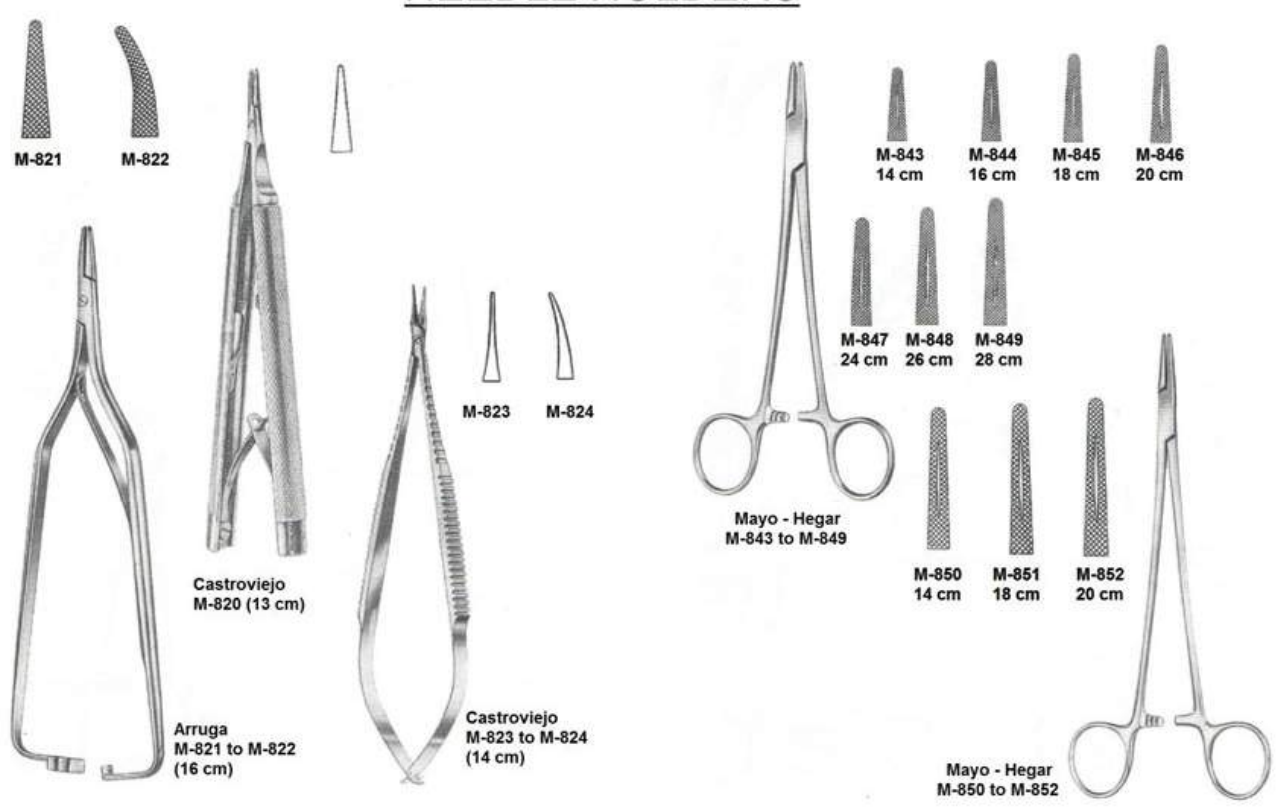

Bozeman Angled Needle Holders (TC & Non-TC)



Debaquey Needle Holder (TC & Non-TC)

NEEDLE HOLDERS

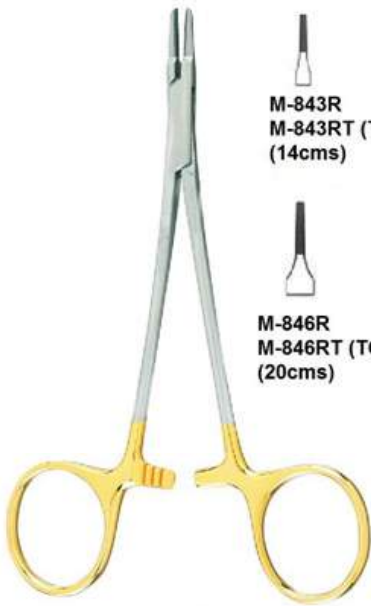

**Ryder Needle Holder
(Regular & TC)**



**M-843R
M-843RT (TC)
(14cms)**



**M-846R
M-846RT (TC)
(20cms)**



**M-844R
M-844RT (TC)
(16cms)**



**M-847R
M-847RT
(24cms)**



**M-845R
M-845RT
(18cms)**



**M-848R
M-848RT
(26cms)**

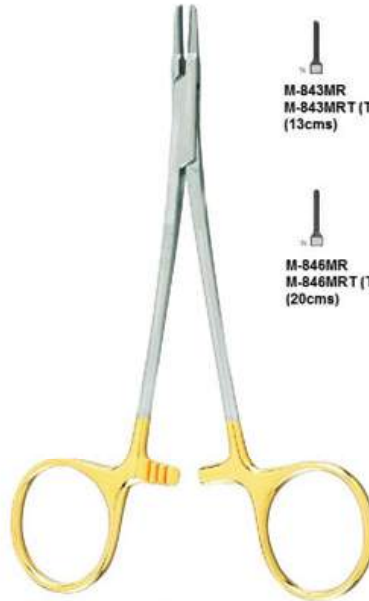

**Mini-Ryder (Ryder-Vascular)
Needle Holder (Extra Fine Tip)
(Regular & TC)**



**M-843MR
M-843MRT (TC)
(13cms)**



**M-846MR
M-846MRT (TC)
(20cms)**



**M-844MR
M-844MRT (TC)
(15cms)**



**M-847MR
M-847MRT (TC)
(23cms)**



**M-845MR
M-845MRT (TC)
(18cms)**



**M-848MR
M-848MRT (TC)
(26cms)**

CLAMPS

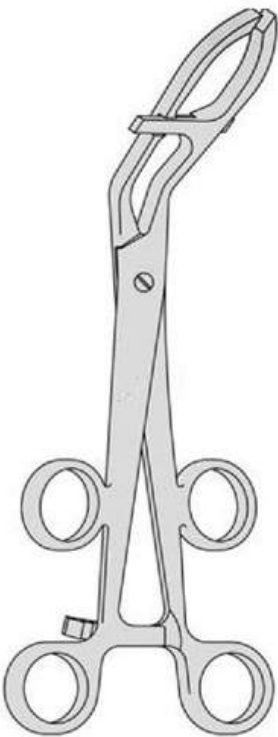

**Boney Myomectomy Clamp
M-2019 (25.5 cms)**



**Tubing Clamps
(Without Safety Guard)
M-2096 (15cm)
M-2097 (20cm)
M-2098 (24cm)**



**Tubing Clamps
(With Safety Guard)
M-2099 (15cm)
M-2100 (20cm)
M-2101 (24cm)**



**Tubing Clamps
(Plain, Heavy Pattern)
M-2102 (15cm)
M-2103 (19cm)
M-2104 (23cm)**

FORCEPS

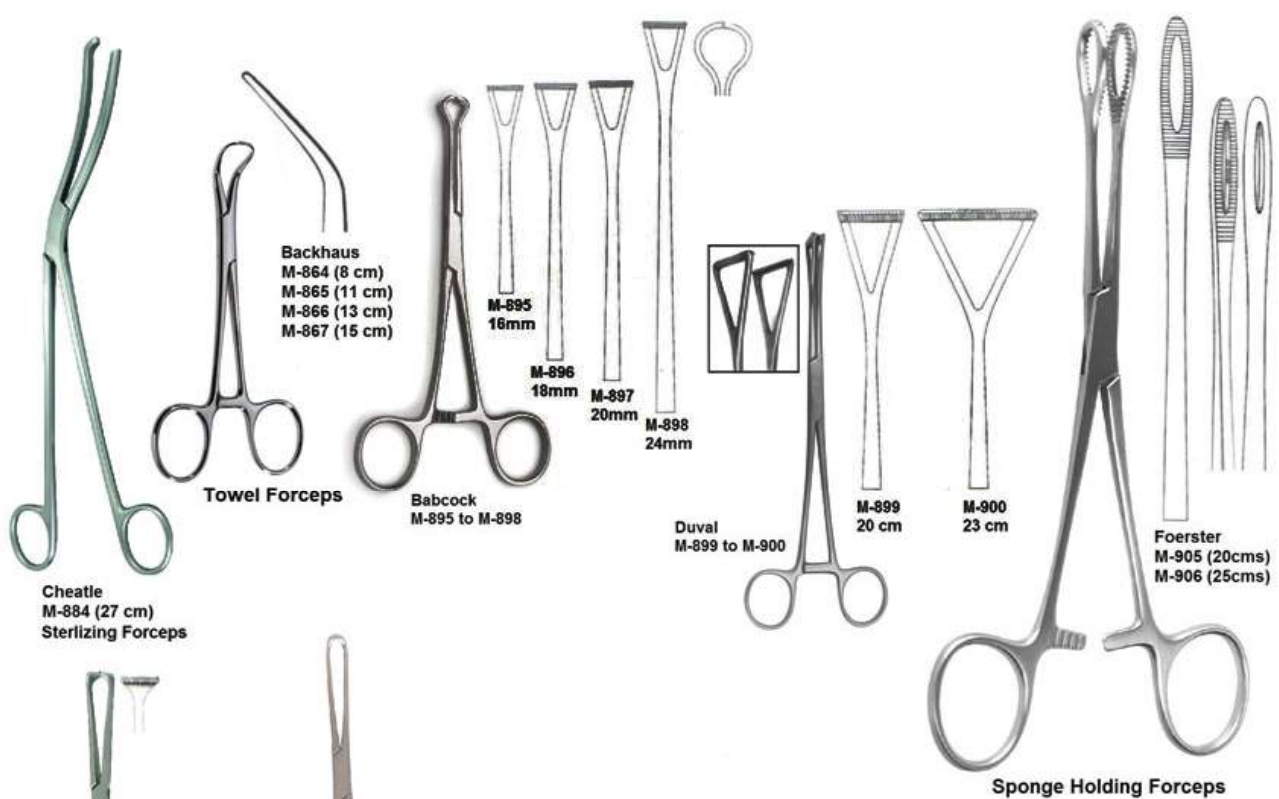

CERVICAL BIOPSY & SPECIMEN FORCEPS

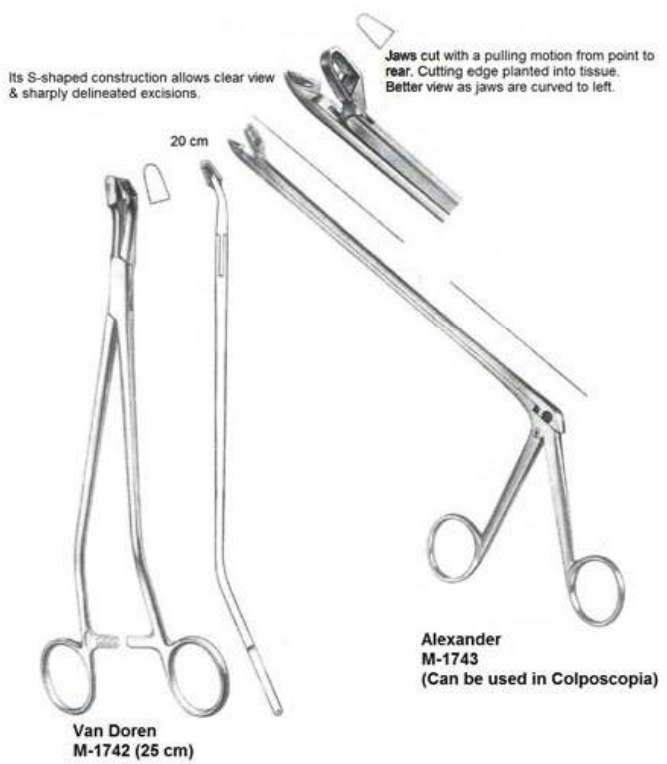
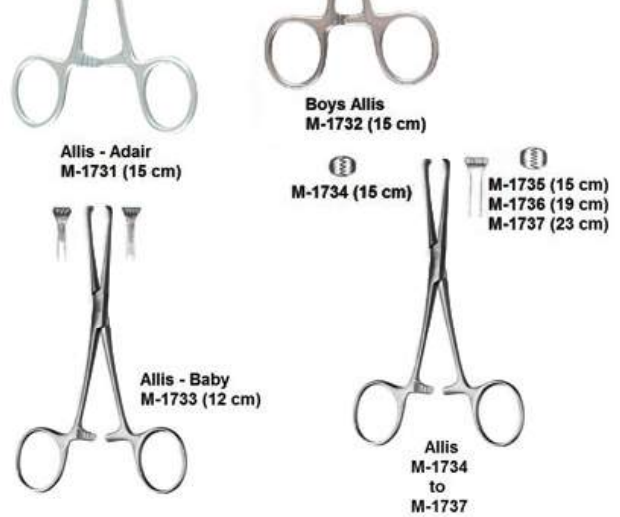

CERVICAL BIOPSY & SPECIMEN FORCEPS

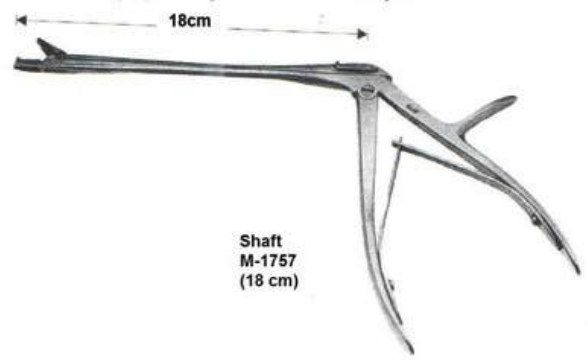

VAGINAL SPECULA



Seyffert
M-1062 (100 X 17mm)
M-1063 (110 X 33mm)



Seyffert
M-1064 (110 X 33mm)



Pederson
M-1065 (75 X 13mm)
M-1066 (100 X 22mm)
M-1067 (120 X 25mm)



Semm
M-1071 (100 X 17/20mm)
M-1072 (100 X 25/30mm)



Grave
M-1068 (75 X 20mm)
M-1069 (95 X 35mm)
M-1070 (115 X 35mm)



Fergusson
M-1073 (Φ 25mm)
M-1074 (Φ 30mm)
M-1075 (Φ 35mm)



Collin
M-1076 (55 X 10mm)

Swiss Pattern



Cusco
M-1082 (80 X 22mm)
M-1083 (100 X 25mm)
M-1084 (105 X 27mm)



Cusco
M-1085 (75 X 32mm)
M-1086 (85 X 35mm)
M-1087 (100 X 37mm)
Japanese Pattern



Collin
M-1088 (65 X 20mm)



Collin
M-1089 (85 X 30mm)
M-1090 (100 X 35mm)
M-1091 (110 X 40mm)
M-1092 (100 X 35mm)



Cusco
M-1077 (75 X 32mm)
M-1078 (85 X 35mm)
M-1079 (100 X 35mm)
M-1080 (85 X 35mm)



Cusco
M-1081 (75 X 17mm)



Collin - Landau
M-1093 (100 X 35mm)



Trélat
M-1094 (85 X 33mm)
M-1095 (95 X 35mm)
M-1096 (115 X 43mm)

VAGINAL SPECULA

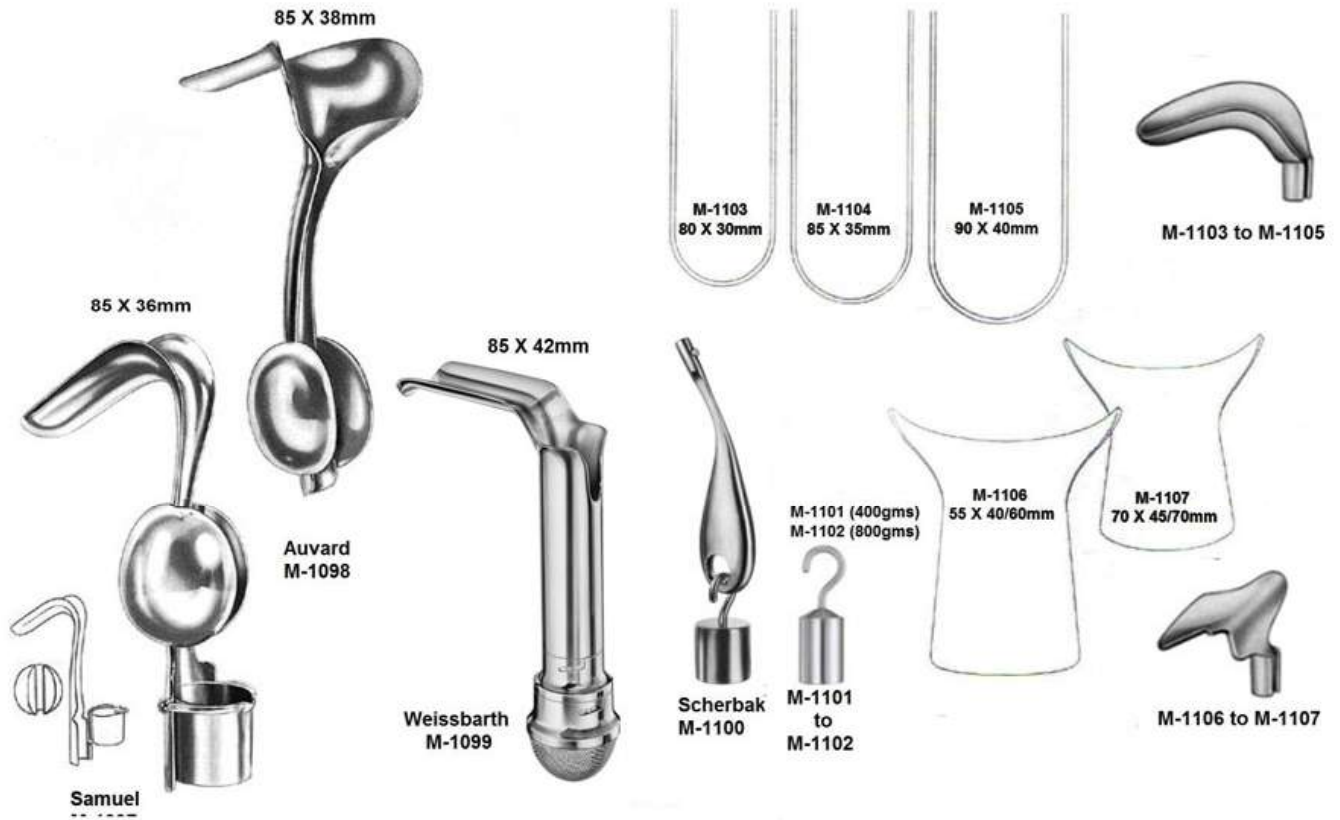

VAGINAL SPECULA & RETRACTORS

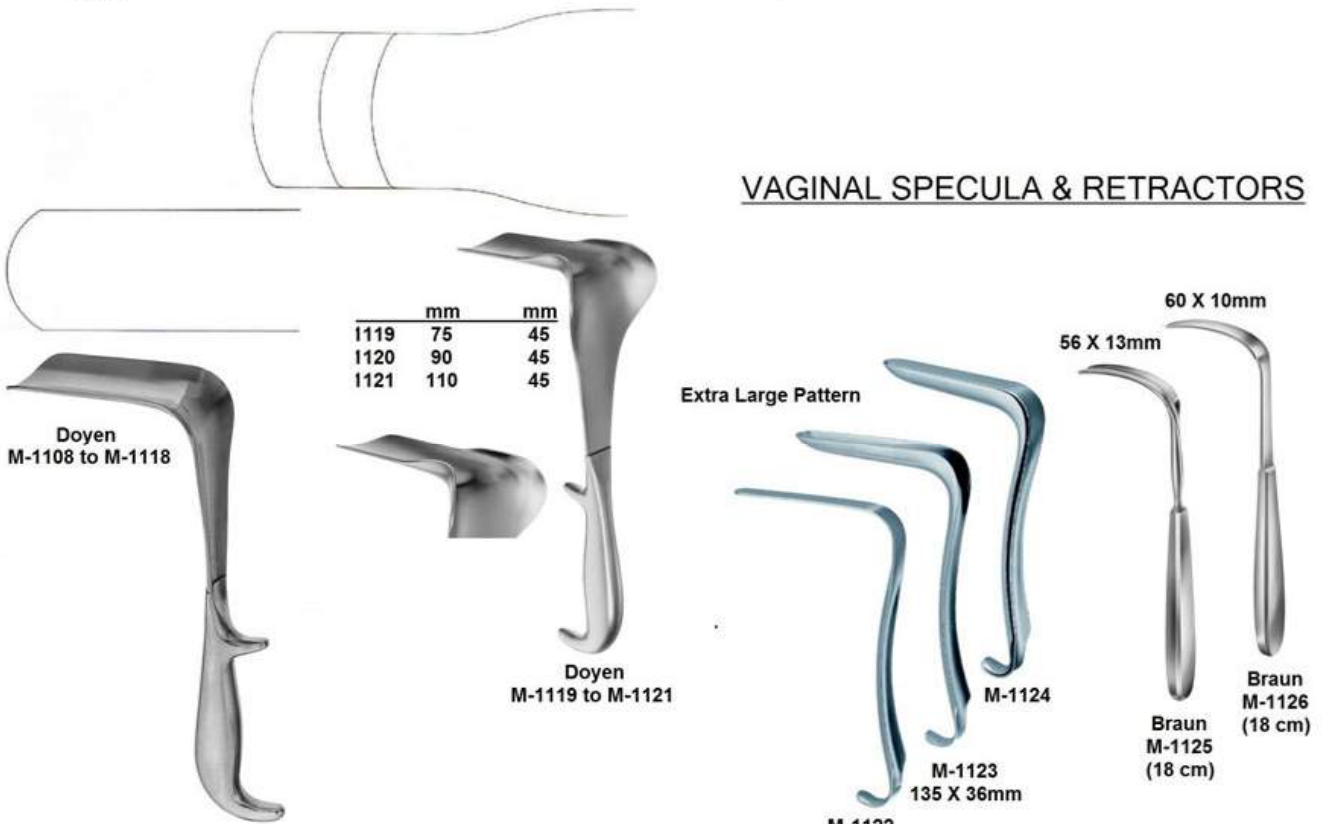

Slightly Concave	mm	mm
M-1108	65	35
M-1109	68	35
M-1110	115	35
<hr/>		
M-1111	55	45
M-1112	55	45
M-1113	115	45
M-1114	160	45
<hr/>		
M-1115	55	60
M-1116	55	60
M-1117	115	60
M-1118	160	60

VAGINAL SPECULA & RETRACTORS

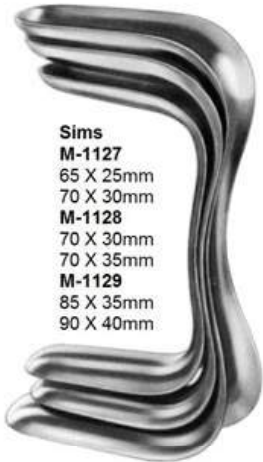

Sims
M-1127
 65 X 25mm
 70 X 30mm
M-1128
 70 X 30mm
 70 X 35mm
M-1129
 85 X 35mm
 90 X 40mm



Jackson
M-1130
 75 X 35mm
M-1131
 90 X 35mm
M-1132
 100 X 35mm
M-1133
 110 X 35mm
M-1134
 90 X 40mm
M-1135
 100 X 40mm



Kristeller (Specula)
M-1144
 70 X 27mm
M-1145
 80 X 30mm
M-1146
 90 X 36mm

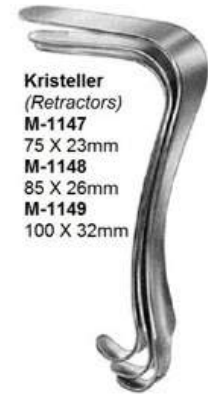

Kristeller (Retractors)
M-1147
 75 X 23mm
M-1148
 85 X 26mm
M-1149
 100 X 32mm



Kristeller (Set of 1 Speculum & 1 Retractor)
M-1150
M-1151
M-1152

With Conically Shaped Blades, Virgin Sizes

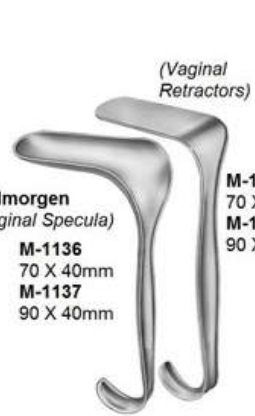

Kallmorgen (Vaginal Specula)
M-1136
 70 X 40mm
M-1137
 90 X 40mm

M-1138
 70 X 33mm
M-1139
 90 X 33mm

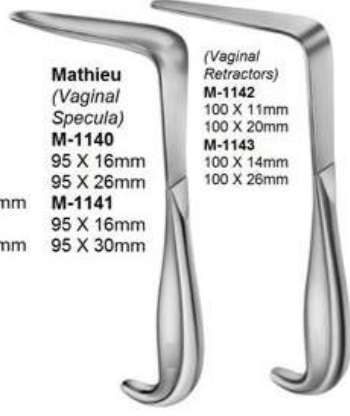

Mathieu (Vaginal Specula)
M-1140
 95 X 16mm
 95 X 26mm
M-1141
 95 X 16mm
 95 X 30mm

(Vaginal Retractors)
M-1142
 100 X 11mm
 100 X 20mm
M-1143
 100 X 14mm
 100 X 26mm



Kristeller (Retractors)
M-1155
 110 X 14mm
M-1156
 110 X 17mm



Kristeller (Specula)
M-1153
 105 X 18mm
M-1154
 105 X 21mm



Kristeller (Set of 1 Speculum & 1 Retractor each)
M-1157
M-1158

Specula Flat Hollow



Specula Deep Hollow



(Specula)
M-1159
 105 X 26mm
M-1160
 105 X 28mm
M-1161
 105 X 33mm



Kristeller (Retractors)
M-1162
 115 X 22mm
M-1163
 115 X 24mm
M-1164
 115 X 29mm



Kristeller (Set of 1 Speculum & 1 Retractor each)
M-1165
M-1166



Kristeller (Specula)
M-1167
 110 X 27mm
M-1168
 110 X 30mm
M-1169
 110 X 36mm



Kristeller (Retractors)
M-1170
 115 X 23mm
M-1171
 115 X 26mm
M-1172
 115 X 32mm



Kristeller (Set of 1 Speculum & 1 Retractor)
M-1173
M-1174
M-1175

RETRACTORS

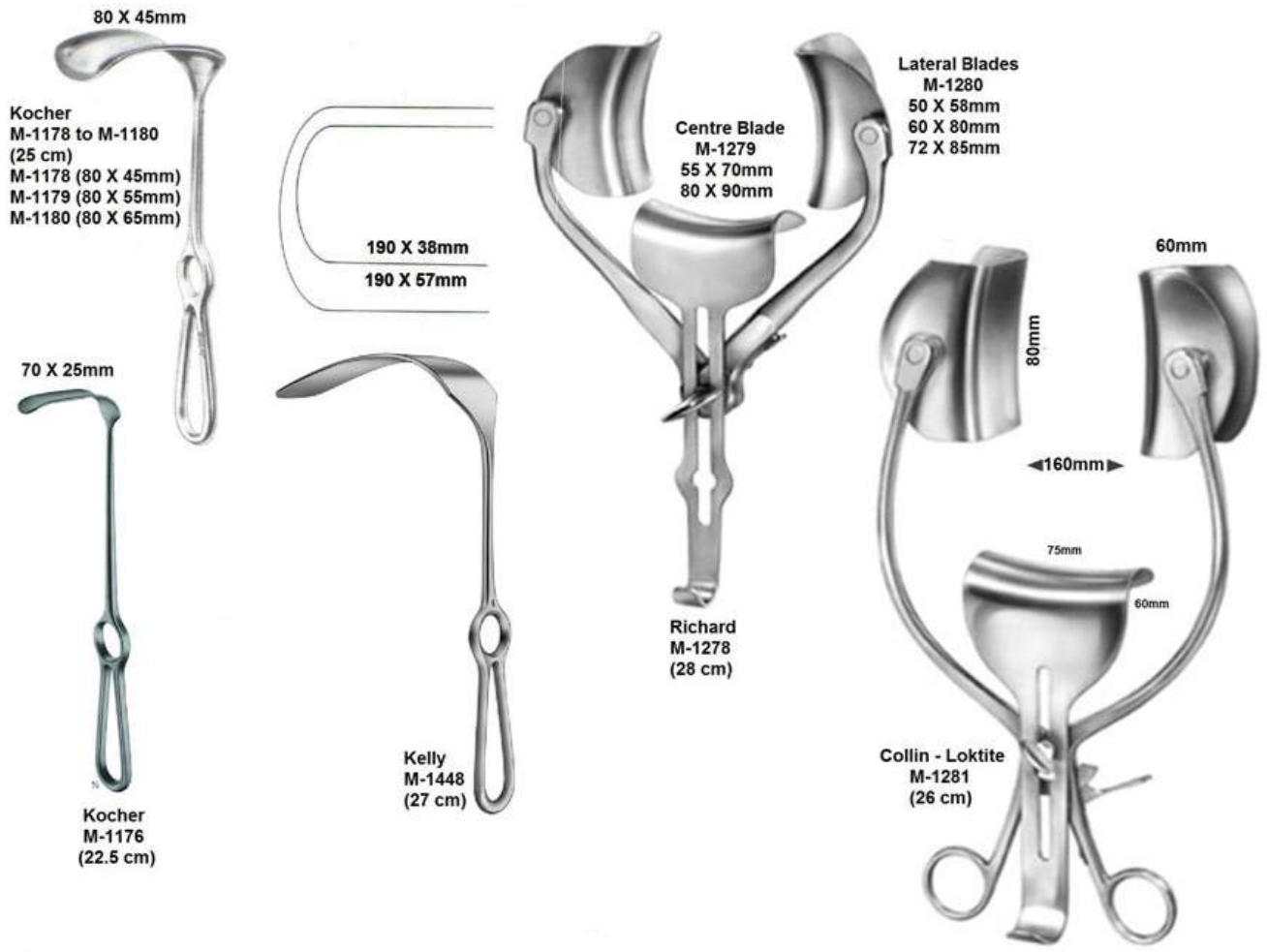

VAGINAL SPECULUM RETRACTORS

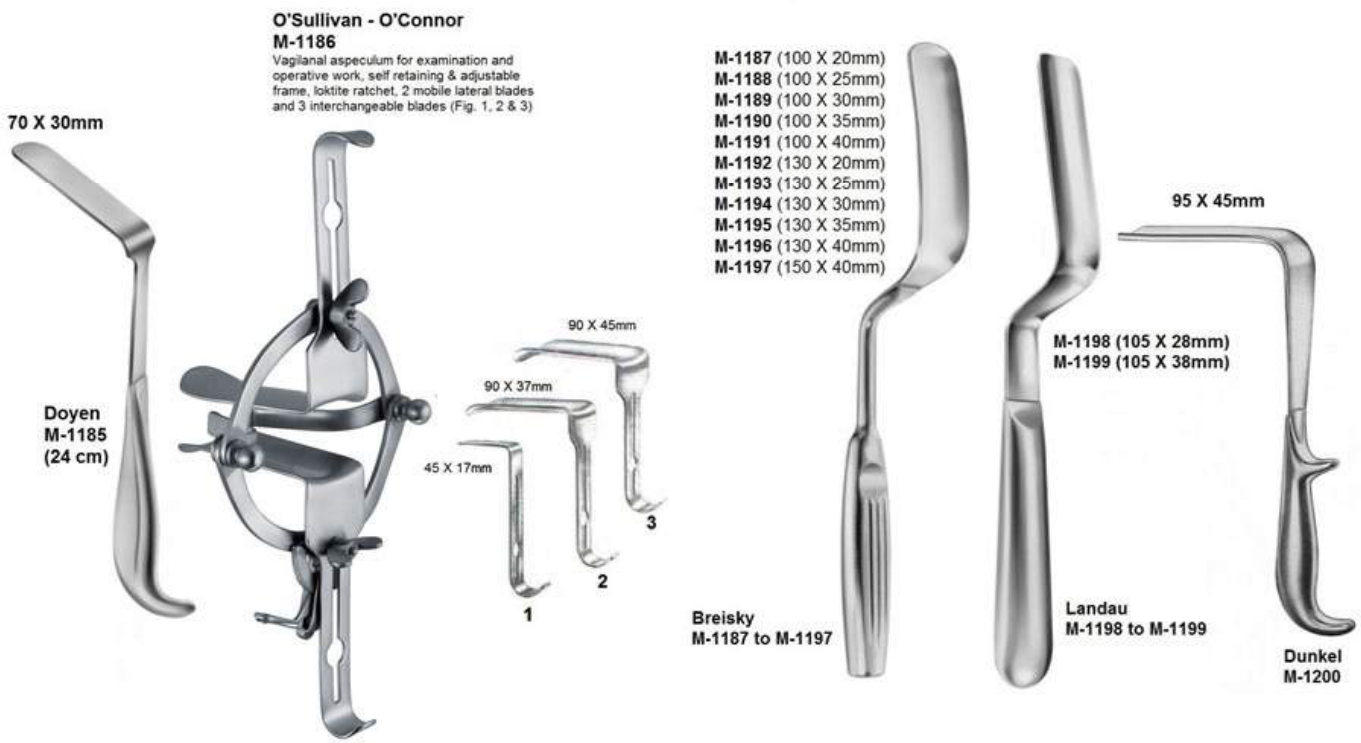

RETRACTORS

Richardson M-1214 to M-1216 (24 cm)
 M-1214 28 X 20mm
 M-1215 36 X 28mm
 M-1216 44 X 38mm

Richardson M-1217 (24 cm)
 52 X 22mm

Kelly M-1218 (26 cm)
 70 X 50mm

Richardson - Eastmann M-1219 (Fig. 1 - 26 cm) M-1220 (Fig. 2 - 28 cm)
 49 X 38mm
 28 X 20mm

Deaver M-1221 (30 cm) M-1222 (30 cm) M-1223 (30 cm) M-1224 (30 cm) M-1225 (36 cm)
 Deaver M-1224-A (23 cm)
 M-1224-B (21.5 cm)
 M-1224-C (18 cm)
 38mm 50mm 75mm 25mm 25mm

Morris Retractors (25cm)
 M-2064 (70 X 40mm)
 M-2065 (70 X 50mm)
 M-2066 (70 X 65mm)

Czerny Retractor (Double Ended) M-1424C (18cm) M-1424D (21cm)
 38 x 22 mm

Doyen Retractor (25cm)
 M-1177 (50 X 75mm)
 M-1177-A (50 X 100mm)
 M-1177-B (55 X 115mm)
 M-1177-C (55 X 125mm)

Mini - Langenbeck M-1348 to M-1351 (16 cm)
 M-1348 M-1349
 M-1350 M-1351

Langenbeck M-1336 to M-1340 (21 cm)
 M-1336 30 X 11mm
 M-1337 30 X 14mm
 M-1338 30 X 16mm
 M-1339 40 X 11mm
 M-1340 50 X 11mm

Consisting of : M-1430 (19 X 22mm) (23 X 30mm) M-1431 (25 X 26mm) (28 X 38mm) M-1432 (28 X 29mm) (33 X 45mm)

Farabeuf M-1428 (12.5 cm)
 25 X 10mm
 22 X 10mm
 28 X 12mm
 32 X 12mm

Roux - Set M-1429 (16.5 cm)

Fritsch (24 cm)
 M-1319 45 X 40mm
 M-1320 45 X 50mm
 M-1321 45 X 60mm
 M-1322 45 X 75mm

RETRACTORS

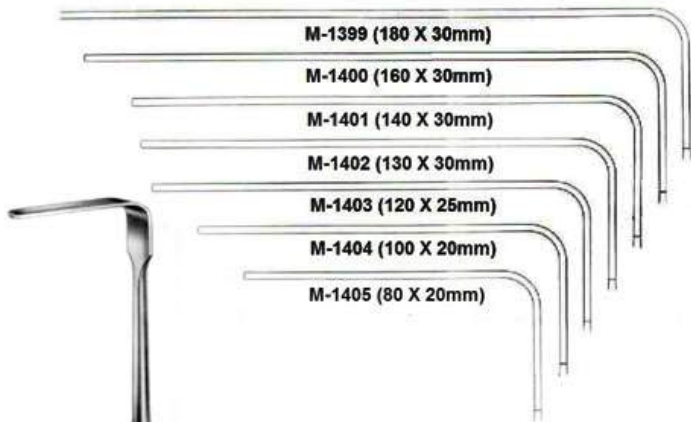

**Brunner
(25 cm)**

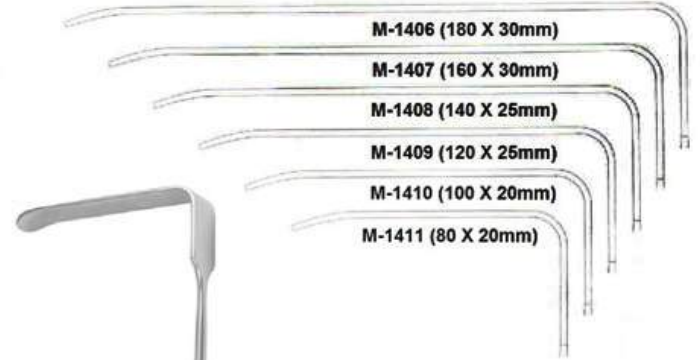

**Brunner
(25 cm)**



**Balfour - Baby
M-1294**



**Balfour
M-1295**



**M-1412
25mm**



**Deaver
(31 cm)**

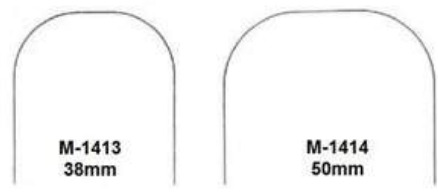

**M-1413
38mm**

**M-1414
50mm**

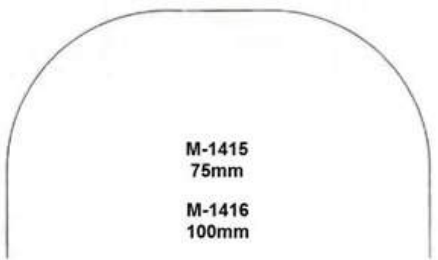

**M-1415
75mm**

**M-1416
100mm**

OBSTETRICAL (MID-WIFERY) FORCEPS



Dee Lee
M-1433
(30 cm)



De Lee
M-1434 (36 cm)
M-1435 (39 cm)



Elliot
M-1436 (32 cm)
M-1437 (38 cm)



Naegele
M-1442 (36 cm)
M-1443 (40 cm)



Simpson - Braun
M-1440 (36 cm)



Simpson
M-1441 (30 cm)



Mc Lean
M-1438 (36 cm)



Simpson - Luikart
M-1439 (36 cm)



specifically for obstetrics in breech presentation



Kielland
M-1444 (41 cm)



Kielland - Luikart
M-1445 (40 cm)



Piper
M-1446 (44 cm)



Ovum Holding Cup Forceps
M-2110 (Small) - 25cms
M-2111 (Medium) - 25cms
M-2112 (Large) - 25cms



Placenta & Ovum Forceps
M-1496.0 (Large) - 25cms
M-1496.1 (Medium) - 25cms
M-1496.2 (Small) - 25cms

TENACULUM FORCEPS



Schroeder
M-1449
(25 cm)



Braun
M-1450
(25 cm)



Duplay
M-1451
(28 cm)



Staude - Moore
(Fergusson)
M-1452
(17 cm)



Barrett
M-1453
(18 cm)



Pozzi
M-1454
(25.5 cm)

RETRACTORS, ENDOSPECULA



Kogan
M-1455
(24 cm)



Kogan
M-1456
(24 cm)



Friedman
M-1457
(10 cm)

M-1458 Retractor, Self-Retaining, for Perineorhaphy
M-1459 Without Ratchet
M-1460 With Scale Ratchet & Fixing Screws



Beacham
M-1461
(26 cm)

Anniotome for the amnion bladder



Skene
M-1462
(24 cm)

With Guide Blades



Abel
M-1463
(27 cm)

TENACULUM FORCEPS

VULSELLUM FORCEPS



UTERINE ELEVATING FORCEPS
&
TENACULUM FORCEPS

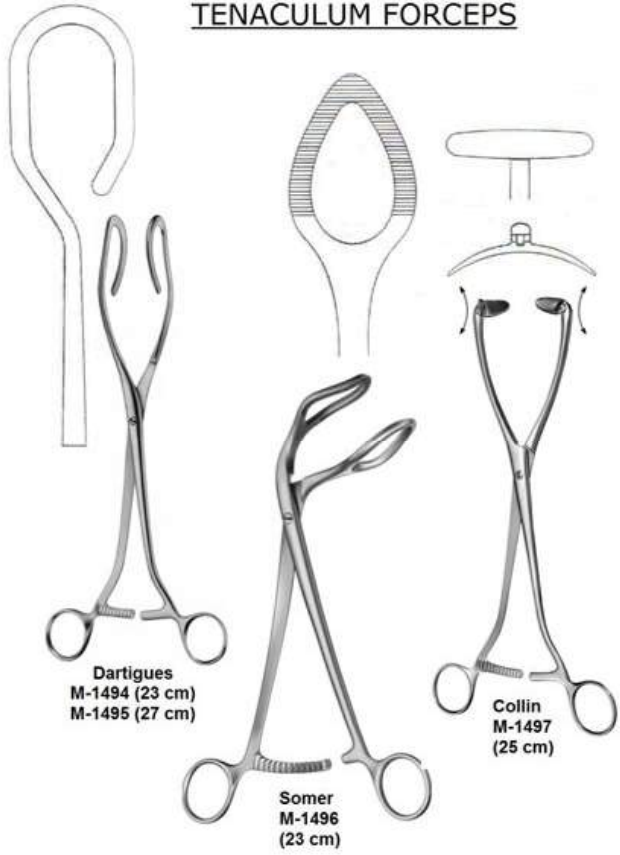

UTERINE POLYPUS FORCEPS



UTERINE ELEVATING & TENACULUM FORCEPS

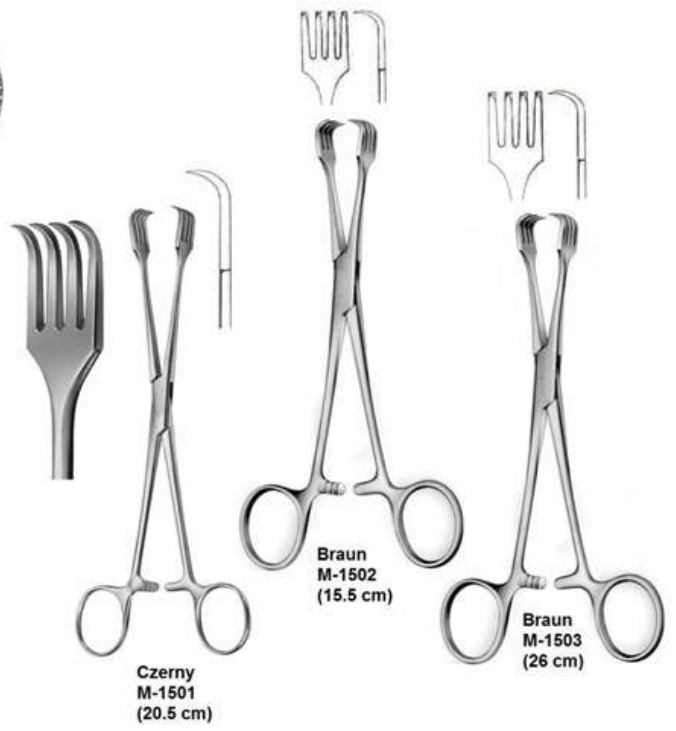

HOOK & CATHETER

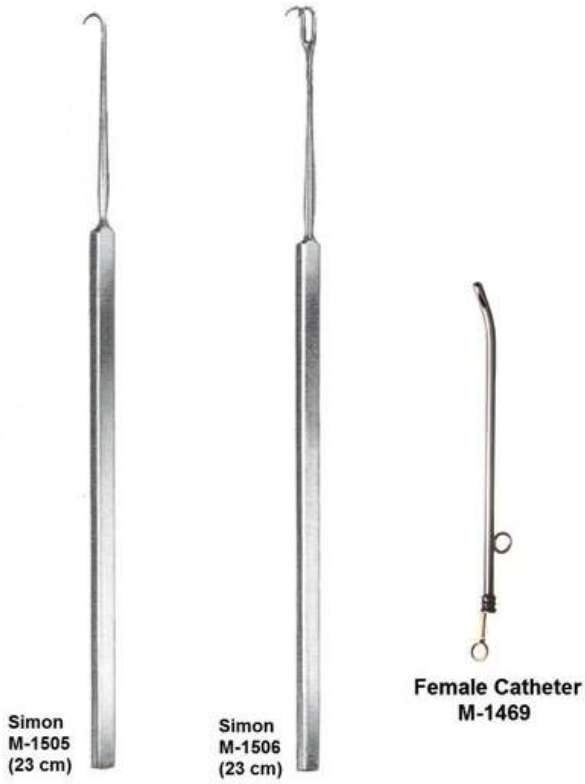

TENACULUM & VULSELLUM FORCEPS



VULSELLUM FORCEPS



MYOMA INSTRUMENTS

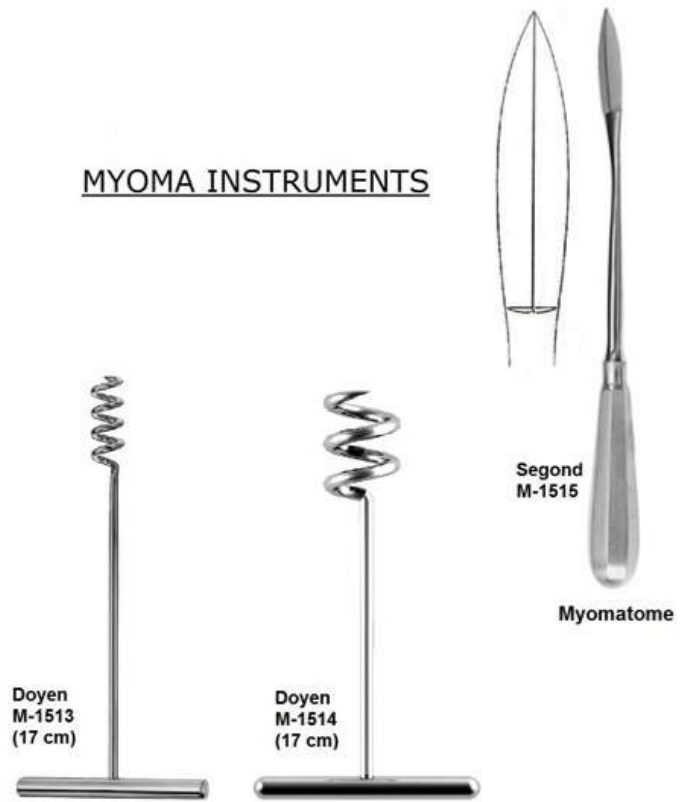

UTERINE SOUNDS & DEPRESSORS



Sims M-1516 (32 cm)
Martin M-1517 (32 cm)
Collin M-1518 (28 cm)
Valleix M-1519 (25 cm)
Braun M-1520 (28 cm)

SUCTION BIOPSY CURETTES

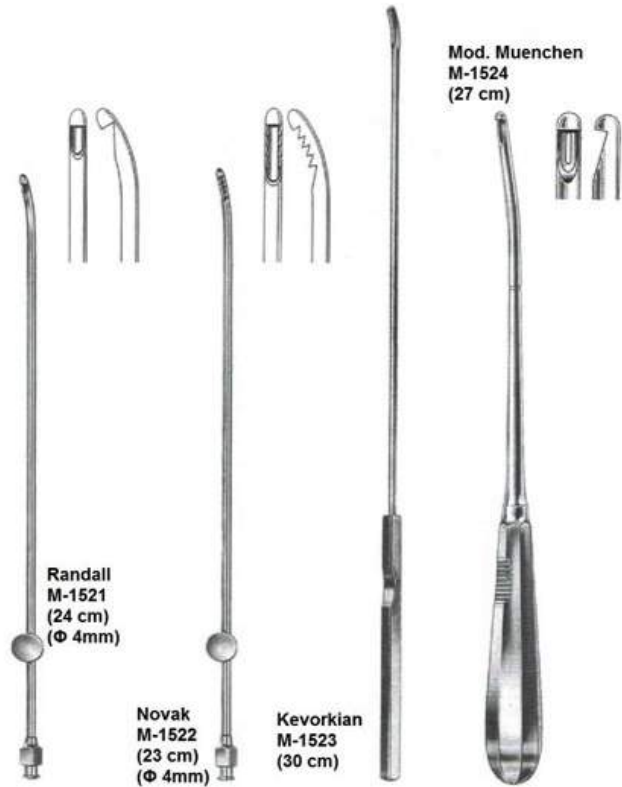

Randall M-1521 (24 cm) (Φ 4mm)
Novak M-1522 (23 cm) (Φ 4mm)
Kevorkian M-1523 (30 cm)
Mod. Muenchen M-1524 (27 cm)

TRANSCERVICAL ASPIRATION INSTRUMENT

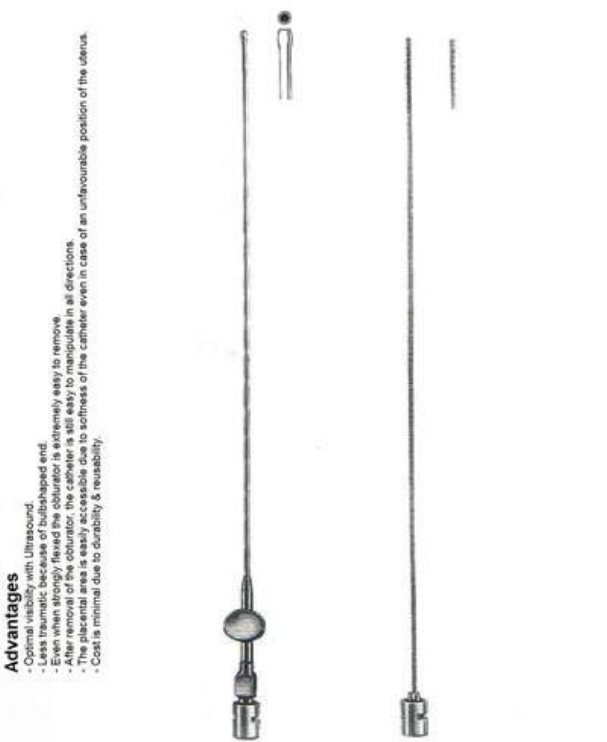

Advantages

- Optimal visibility with Ultrasound.
- Low insertion force due to beakhead end.
- Even when strongly flexed the obturator is extremely easy to remove.
- After removal of the obturator, the catheter is still easy to manipulate in all directions.
- The placental area is easily accessible due to softness of the catheter even in case of an unfavourable position of the uterus.
- Cost is minimal due to durability & reusability.

Kloosterman M-1525 to M-1526
M-1525 (Set Complete, 27cm, Φ 2mm)
M-1526 (Mandrel Only)

OVUM CURETTES, ABORTION SCOOPS, UMBILICAL CLAMPS

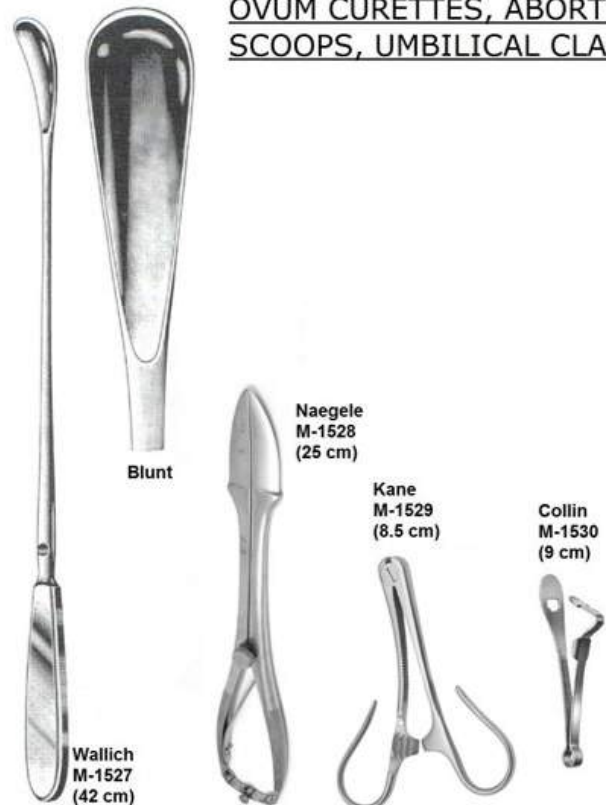

Wallich M-1527 (42 cm)
Blunt
Naegele M-1528 (25 cm)
Kane M-1529 (8.5 cm)
Collin M-1530 (9 cm)

OVUM CURETTES, ABORTION SCOOPS

PELVIMETERS



Martin M-1531 (34 cm)
cm/inch scale



Collin M-1532 (35 cm)
cm scale



Breisky M-1533 (33 cm)
cm/inch scale

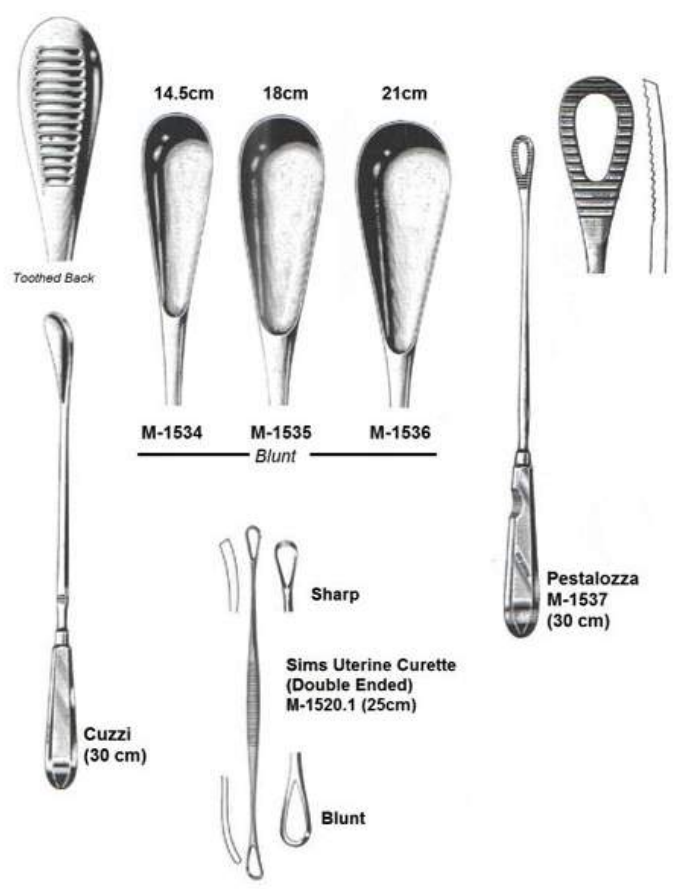

UTERINE SCOOPS

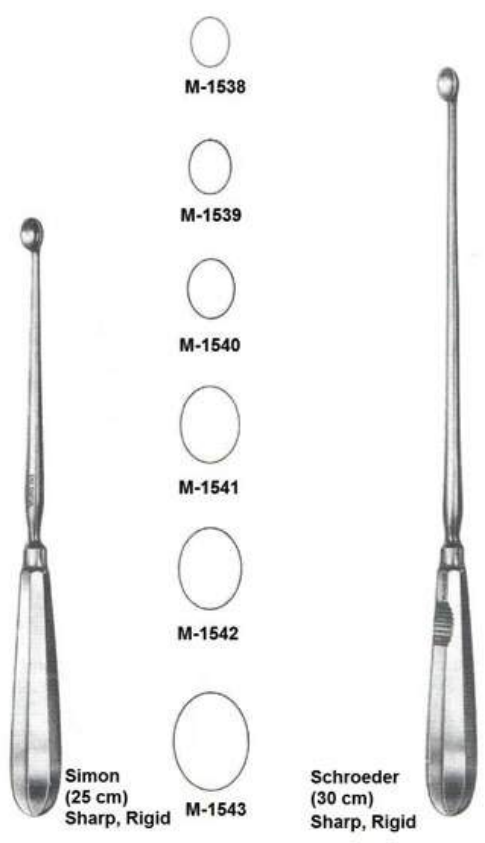

UTERINE SCOOPS

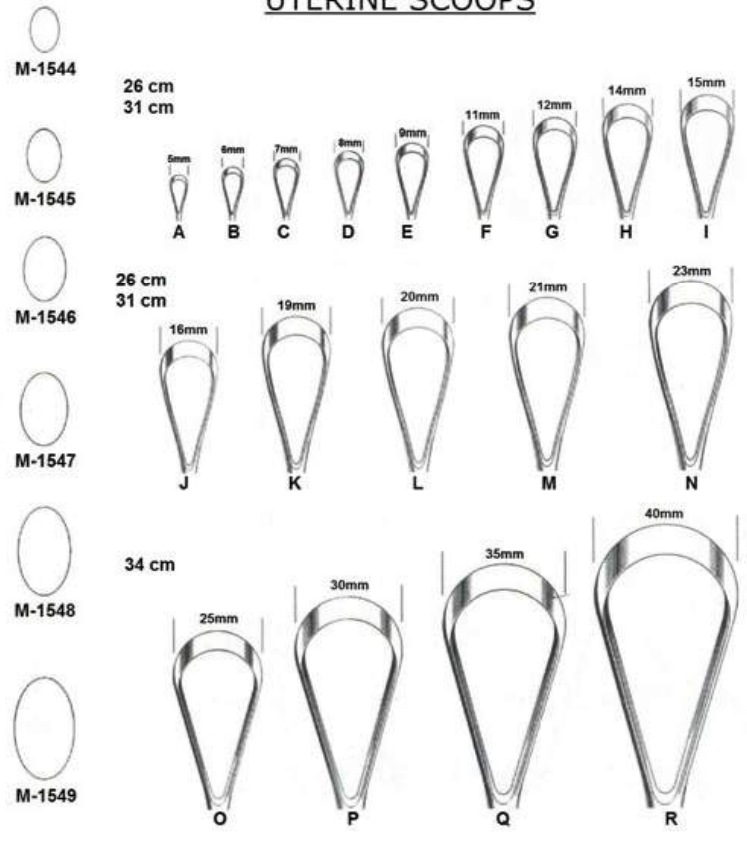

CERVICAL BIOPSY & SPECIMEN FORCEPS

Its S-shaped construction allows clear view & sharply delineated excisions.

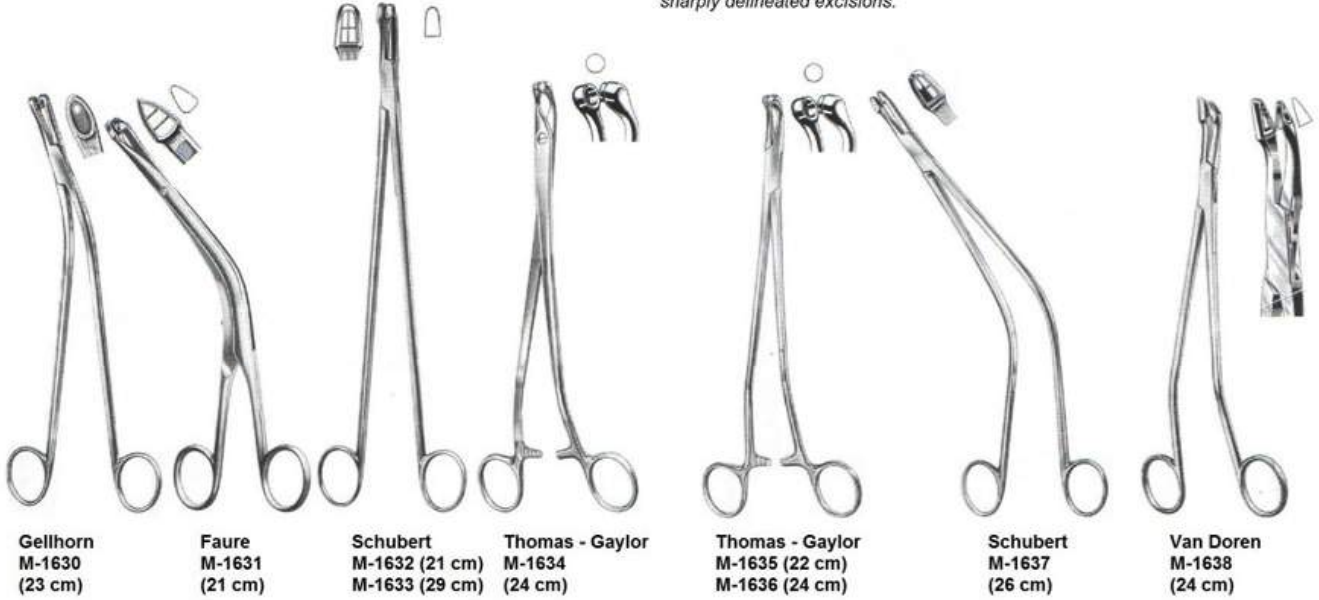

Gellhorn
M-1630
(23 cm)

Faure
M-1631
(21 cm)

Schubert
M-1632 (21 cm)
M-1633 (29 cm)

Thomas - Gaylor
M-1634
(24 cm)

Thomas - Gaylor
M-1635 (22 cm)
M-1636 (24 cm)

Schubert
M-1637
(26 cm)

Van Doren
M-1638
(24 cm)

ASPIRATING CURETTES

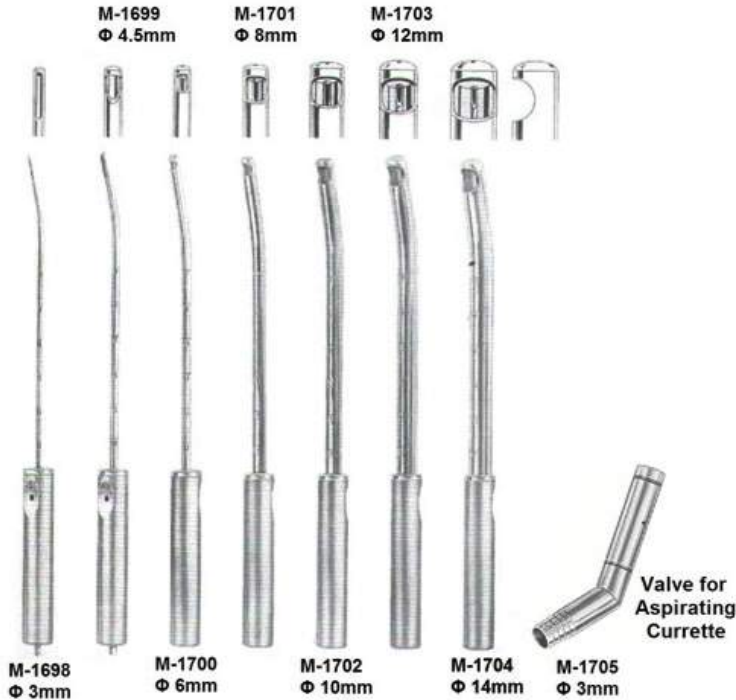

M-1699
Φ 4.5mm

M-1701
Φ 8mm

M-1703
Φ 12mm

M-1698
Φ 3mm

M-1700
Φ 6mm

M-1702
Φ 10mm

M-1704
Φ 14mm

M-1705
Φ 3mm

Valve for Aspirating Curette

RETRACTORS

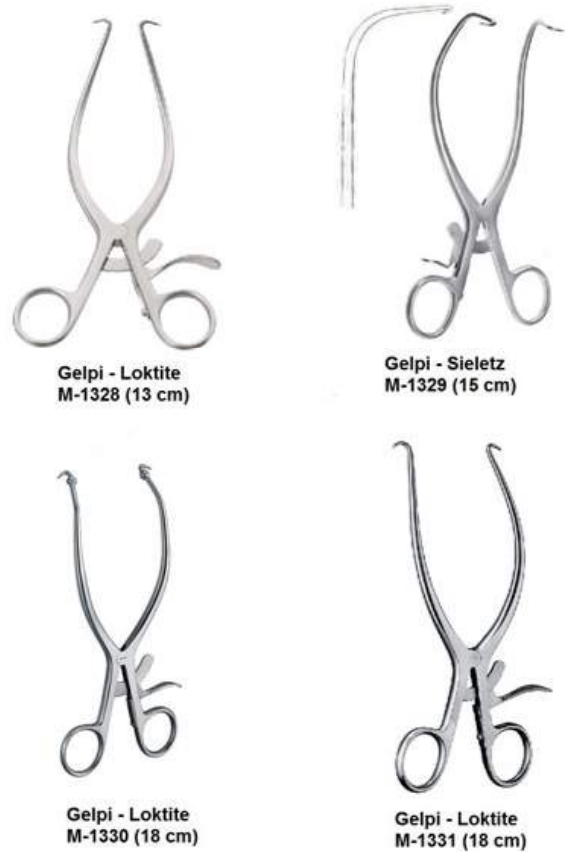

Gelpi - Loktite
M-1328 (13 cm)

Gelpi - Siefert
M-1329 (15 cm)

Gelpi - Loktite
M-1330 (18 cm)

Gelpi - Loktite
M-1331 (18 cm)

UTERINE DILATORS

M-1639
Set of 8 Dilators
Φ3.0/4.0mm - Φ17.0/18.0mm
in boilable canvas roll



M-1640
Set of 5 Dilators



Hank M-1643
Set of 6 Dilators
(in canvas roll)



M-1641
Set of 13 Dilators
Φ1.0/2.0mm - Φ25.0/26.0mm
(in metal case with hinged lid)



M-1642
Set of 15 Dilators

American Scale

Hank M-1644 to M-1649

- Hank M-1644** Φ4.5-5mm
- M-1645** Φ5.5-6mm
- M-1646** Φ6.5-7mm
- M-1647** Φ7.5-8mm
- M-1648** Φ8.5-9mm
- M-1649** Φ9.5-10mm

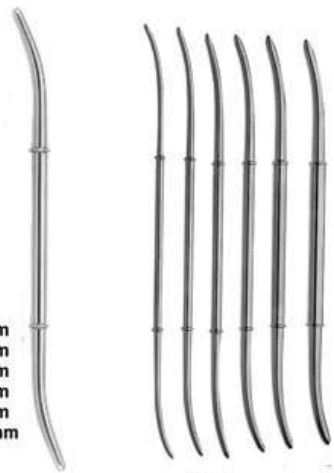

Hank M-1650
Set of 6 Dilators

UTERINE

M-1651 (Set of 14 Dilators)
(Φ4.0-17.0mm), In metal case with hinged lid

M-1652 (Set of 26 Dilators)
(Φ1.0-26.0mm), In metal case with hinged lid



	Φ mm
M-1653	- 1.0/2.0
M-1654	- 3.0/4.0
M-1655	- 5.0/8.0
M-1656	- 7.0/8.0
M-1657	- 9.0/10
M-1658	- 11/12
M-1659	- 13/14
M-1660	- 15/16
M-1661	- 17/18
M-1662	- 19/20
M-1663	- 21/22
M-1664	- 23/24
M-1665	- 25/26

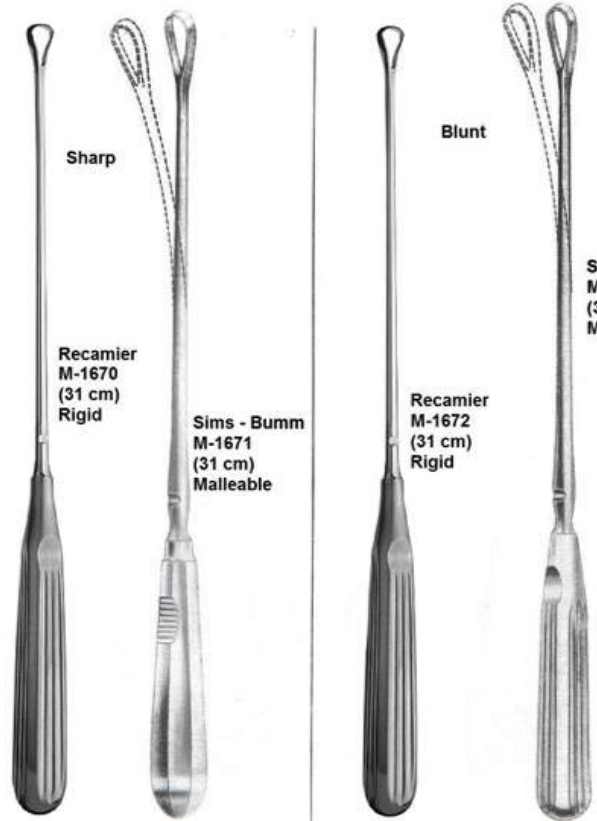

Sharp

Blunt

Recamier M-1670 (31 cm) Rigid

Sims - Bumm M-1671 (31 cm) Malleable

Recamier M-1672 (31 cm) Rigid

Sims - Bumm M-1673 (31 cm) Malleable

Pieces Per Set	Set
14	M-1666
26	M-1667

M-1668
Set of 8 Dilators Φ3.0/4.0mm - Φ17.0/18.0mm

M-1669
Set of 13 Dilators Φ1.0/2.0mm - Φ15.0/26.0mm



FusionKraft™



by

Myra & Company

(An ISO 9001 : 2008 Certified Company)

293, Ground Floor, Niti Khand -2, Indirapuram.
Ghaziabad. U.P.-201010. INDIA

Ph: +91 - 120 - 653 0330 (8 Lines)
Mob: +91 - 99999 06920, +91 - 98108 13683
Hotline: +91 - 120 - 640 1193

Email: org@myraandcompany.in

www.myraandcompany.in

FusionKraft™ is a trademark of Myra & Co., India. Copyright © 2014 Myra & Co. All rights reserved.

The information presented in this catalogue is intended to demonstrate a FusionKraft™ product only. Myra & Co. reserves the right to make any alterations in the information/technical specifications without any prior notice. No part of this catalogue may be reproduced, stored in or introduced into a retrieval system, or transmitted, in any form or by any means (electronic, mechanical, photocopying, recording, or otherwise) without the prior written permission.